



GOLD SILK
Shanghai Gold Metal Materials, Ltd

上海金缕金属材料有限公司



金缕简介 Profile

上海金缕金属材料有限公司成立于2007年，是建筑装饰金属网行业新崛起的一股新生力量，融合设计、生产、贸易及安装于一体，主要经营内容涵盖5个大类上百种产品，其中包括：建筑金属装饰网、金属布、金属网帘、金属环网、金属珠帘等，广泛应用于建筑装饰领域，范围包括幕墙、吊顶、隔断、橱窗展示等，针对的市场涉及建筑工程，餐饮娱乐，房产物业，零售百货等多个行业。

通过现代化的生产技术和独到的设计理念，为我们提供高品质产品打下扎实的基础，为我们在客户中赢得了良好的口碑，优秀的技术团队能及时为客户提供定制和安装的解决方案，周到的服务让金缕两字在建筑设计业内口口相传，更是与多家设计单位和企业间建立了长期的战略合作伙伴关系。

在三年的艰苦卓绝中，已拥有承接大中型建筑工程项目的丰富经验。业务覆盖全国各地，在海外市场的业绩也初露锋芒，出口美国、法国、比利时、阿联酋、捷克、日本、韩国、马来西亚、新加坡、泰国、科威特等国家，金缕公司凭借优质产品，高效服务和商誉为（中国制造）这个民族群体品牌形象塑造增添了一份自己的力量。

随着市场的变化，金缕紧握市场契机，以打造高品质建材、推广节能环保、引领设计风尚为企业目标，不断进取。上海金缕金属材料有限公司愿与广大建筑设计企业携手合作，为建筑装饰产业再创新的高度而努力。

Founded in 2007, **Shanghai Gold Metal Materials, Ltd** is an emerging new force in the industry of decorative metal mesh. We are committed to design, production, trading and installation of metal mesh which covers 5 categories and hundred of items including: wire mesh, metal drapery, wire drapery, ring mesh, metal bead curtain, ect.... Our products are widely decorated as wall cladding, ceiling, partition and exhibitions for constructions, dinning & entertainment, property management, retailers or shopping malls.

Our team of technicians are ready to design quality decorations for your feature designs and can provide you with complete solutions for your design and installation ideas. Through years of kind service we have got a close relations with architecturers and designers. Our products are enjoying a great popularity in the decoration industry both at home and abroad. We have done several large projects across the country and succeeded in exporting to quite a few countries, such as United States, France, Belgium, United Arab Emirates, Czech Republic, Japan, Korea, Malaysia, Singapore, Thailand, Kuwait and other countries.

We will still do our best to serve our clients with quality products and strive to produce energy saving and environmental products in the decoration industry.

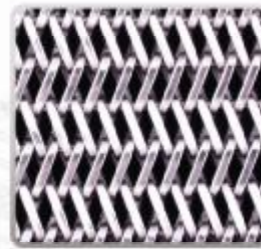

JS-1185

杆径: warp	1.5mm
丝径: wire dia	1.0mmX2.0mm
节距: pitch	8.0mm
螺距: pitch of screw	5.0mm



JV-3810

绳径: rope dia	2.0mmX3
绳距: rope clearance	80mm
杆径: weft rod diameter	3.0mm
杆距: rod pitch	10.0mm
重量: weight	6.6kg/m ²



JV-436

绳径: rope dia	1.0mmX4
绳距: rope clearance	36mm
杆径: weft rod diameter	2.0mm
杆距: rod pitch	4.0mm
重量: weight	7.0kg/m ²

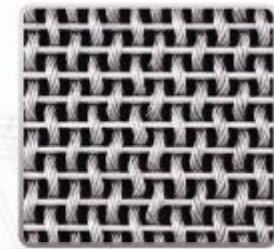

JS-4252

绳径: rope dia	2.5mmX1
绳距: rope clearance	5.0mm
杆径: weft rod diameter	2.0mm
杆距: rod pitch	6.0mm
重量: weight	12.2kg/m ²

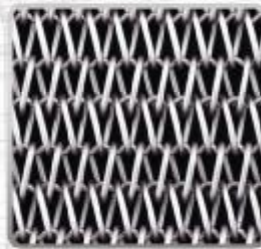

JS-1174

杆径: warp	1.2mm
丝径: wire dia	1.2mm
节距: pitch	7.0mm
螺距: pitch of screw	4.3mm

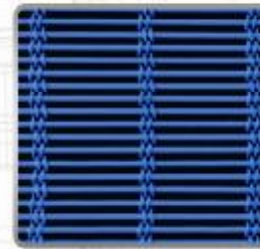

JV-426L

绳径: rope dia	0.75mmX4
绳距: rope clearance	26.4mm
杆径: weft rod diameter	1.5mm
杆距: rod pitch	3.0mm
重量: weight	5.3kg/m ²



JV-436D

绳径: rope dia	1.0mmX4
绳距: rope clearance	36mm
杆径: weft rod diameter	2.0mm
杆距: rod pitch	4.0mm
重量: weight	7.0kg/m ²



JV-4305T

绳径: rope dia	0.45mmX3
绳距: rope clearance	3.5mm
杆径: weft rod diameter	0.5mm
杆距: rod pitch	1.6mm
重量: weight	2.1kg/m ²

编织网 Wire mesh

经纬交错，结合了柔韧与刚硬，无论使用在幕墙，吊顶还是隔断，都能起到意想不到的视觉效果，设计师可充分发挥它的可变性，使其为建筑带来非同一般的精彩展现。

Weft and warp weaved and combined soft with rigid, wire mesh can be widely applied to the decoration industry to create any effect the designer can dream.



JV-6517

丝径: wire dia	2.0mmX1
丝径距: clearance between wire center	8.0mm
纬丝: weft wire	1.5mm
纬丝距: clearance between weft wire	1.5mm
重量: clearance between weft wire	12.7kg/m ²



JV-6148

丝径: wire dia	1.5mm
丝径距: clearance between wire center	9.3mm
纬丝: weft wire	1.5mmX2
纬丝距: clearance between weft wire	2.5mm
重量: clearance between weft wire	11.6kg/m ²



JV-8216

扁条: wire dia	2.7mmX2
扁条距: clearance between flat wire	26.0mm
杆径: weft rod diameter	2.7mmX2
杆距: rod pitch	26.0mm
重量: clearance between weft wire	2.58kg/m ²



JV-8156

扁条: wire dia	1.5mmX6
扁条距: clearance between flat wire	12.0mm
杆径: weft rod diameter	1.5mmX6
杆距: rod pitch	12.0mm
重量: clearance between weft wire	12.23kg/m ²



JV-1530

绳径: rope dia	2.0mmX1
绳距: rope clearance	17.5mm
杆径: weft rod diameter	1.5mm
杆距: rod pitch	1.5mm
重量: weight	11kg/m ²



JV-5215

丝径: wire dia	2.0mmX1
丝径距: clearance between wire center	17.5mm



JV-1537

绳径: rope dia	2.0mmX1
绳距: rope clearance	17.5mm
杆径: weft rod diameter	1.5mm
杆距: rod pitch	3.75mm
重量: weight	5.26kg/m ²



JV-6212

丝径: rope dia	1.2mmX2
丝径距: rope clearance	17.5mm
杆径: weft rod diameter	2.0mm
杆距: rod pitch	4.0mm
重量: weight	7.4kg/m ²

轧花网 Crimped Wire Mesh

在柔韧性和通透性上虽不及编织网，但在整体性和反光度上更有优势，具有更为密集的刚性，简约中体现地现代感十足，轧花网独有的纹理使得建筑更具生命力。

In view of permeability and softness, the crimped wire mesh can not compare with that of common wire mesh, as for Integrity, irritability and reflection it has more advantages. It is simple and modern and has typical texture which enforced its life in architecture industry.



KZ-1541

板厚: thickness	1.5mm
梗宽: strand	5.0mm
长节距: LWD	40.0mm
短节距: SWD	15.0mm
重量: weight	3.0kg/㎡



KZ-1321

板厚: thickness	1.0mm
梗宽: strand	3.0mm
长节距: LWD	25.0mm
短节距: SWD	13.0mm
重量: weight	1.4kg/㎡



KZ-1231(银灰)

板厚: thickness	1.5mm
梗宽: strand	2.0mm
长节距: LWD	30.8mm
短节距: SWD	12.0mm
重量: weight	2.3kg/㎡



KZ-1231(金色)

板厚: thickness	1.5mm
梗宽: strand	2.0mm
长节距: LWD	30.0mm
短节距: SWD	12.0mm
重量: weight	2.3kg/㎡

扩张网 Expanded mesh

具有很强的实用性，融合装饰功能和防护功能，通透性会根据安装的位置与人的移动而变化，波浪形的外观在大面积使用后呈现出如海浪般磅礴的效果。

The expanded metal mesh can be both decorative or protective materials which are permeable and aesthetics especially applied for large area.



KZ-1361

板厚: thickness	1.0mm
梗宽: strand	3.0mm
长节距: LWD	60.0mm
短节距: SWD	11.0mm
重量: weight	4.7kg/㎡



KZ-1351

板厚: thickness	1.2mm
梗宽: strand	3.0mm
长节距: LWD	50.0mm
短节距: SWD	10.0mm
重量: weight	1.8kg/㎡



KZ-1651

板厚: thickness	1.5mm
梗宽: strand	6.0mm
长节距: LWD	50.0mm
短节距: SWD	16.0mm
重量: weight	9.7kg/㎡

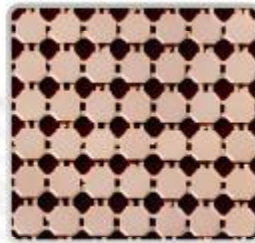

L-6009

材质: material AL
规格: spec 6.0mm
重量: weight 1.21kg/m²



L-6002

材质: material AL
规格: spec 6.0mm
重量: weight 1.21kg/m²



L-6005

材质: material AL
规格: spec 6.0mm
重量: weight 1.21kg/m²



L-6007

材质: material AL
规格: spec 6.0mm
重量: weight 1.21kg/m²



L-3001

材质: material AL
规格: spec 3.0mm
重量: weight 0.78kg/m²



L-4001

材质: material AL
规格: spec 4.0mm
重量: weight 1.01kg/m²



L-4007

材质: material AL
规格: spec 4.0mm
重量: weight 1.01kg/m²



L-4006

材质: material AL
规格: spec 4.0mm
重量: weight 1.01kg/m²

光面金属布 Polished Metal Drapery

金属布是由多个单独铝片咬合卡扣所组成，铺平后像竹席般平整，光面金属布通过电镀工艺着色，在光线和角度的变化下呈现出鱼鳞般迷人的色彩，广泛用作酒店，舞厅等娱乐场所，既可做屏风也可作为隔断使用，是最新的时尚装饰材料。

The drapery is weaved by particles of aluminum and plated after weaving into a flat piece. After installation in hotel, ball room or other entertainment, it can reflect effects of scales under the light. The drapery is really the most ideal fashionable decoration materials.

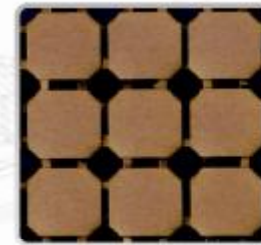

S-1002

材质: material	AL
规格: spec	10.0mm
重量: weight	1.80kg/m ²

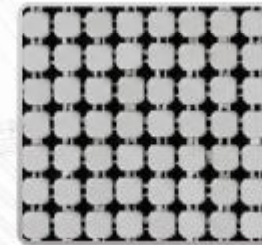

S-1001

材质: material	AL
规格: spec	10.0mm
重量: weight	1.80kg/m ²

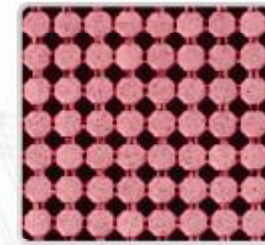

Q-3001

材质: material	AL
规格: spec	3.0mm
重量: weight	0.78kg/m ²



S-3004

材质: material	AL
规格: spec	3.0mm
重量: weight	0.78kg/m ²



S-3005

材质: material	AL
规格: spec	3.0mm
重量: weight	0.78kg/m ²



S-3008

材质: material	AL
规格: spec	3.0mm
重量: weight	0.78kg/m ²

磨砂面金属布 Sanded Metal Drapery

磨砂面金属布通过不同的工艺将金属布表面处理为糙面质感，在反光度上也与光面金属布截然不同，如果光面金属布代表张扬和时尚，那磨砂面金属布则象征着内敛和沉稳，为迎合客户的不同需要，增添多一种的选择。

The drapery is furnished by special sanded surface in order to produce an effect of restrain and calm and satisfy different requirement of decoration. The polishing drapery represents the effects of publicity and fashion.

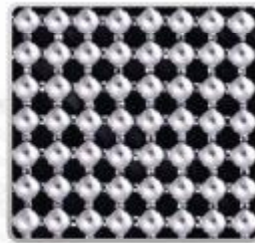

L-3006

材质: material	AL
规格: spec	6.0mm
重量: weight	1.21kg/m ²



L-4004

材质: material	AL
规格: spec	6.0mm
重量: weight	1.21kg/m ²



L-4005

材质: material	AL
规格: spec	6.0mm
重量: weight	1.21kg/m ²

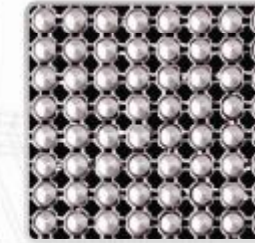

Z-3001

材质: material	AL
规格: spec	6.0mm
重量: weight	2.20kg/m ²



H-3003

材质: material	AL
规格: spec	3.0mm
重量: weight	0.78/m ²



W-4001

材质: material	AL
规格: spec	4.0mm
重量: weight	1.01kg/m ²

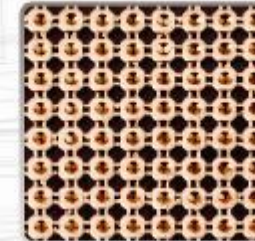

S-4001

材质: material	AL
规格: spec	4.0mm
重量: weight	1.01kg/m ²

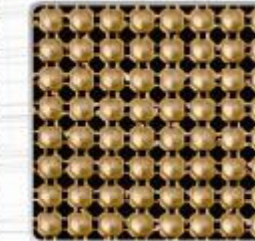

Z-3002

材质: material	AL
规格: spec	3.0mm
重量: weight	2.20kg/m ²

特殊颗粒金属布 Special particles of metal drapery

特殊颗粒金属布由有多种异形颗粒面组成，立体感强，折光面多，大面积使用时能体现出别样的质感，更显高雅华贵。

The special particles of metal drapery is composed of different shapes of particles which have more dimensional and refractive index of the many aspects.



顶装配件
top - instal accessory

直轨+滑轮
straight track+pulley

夹片
jaw

金属布
metal drapery

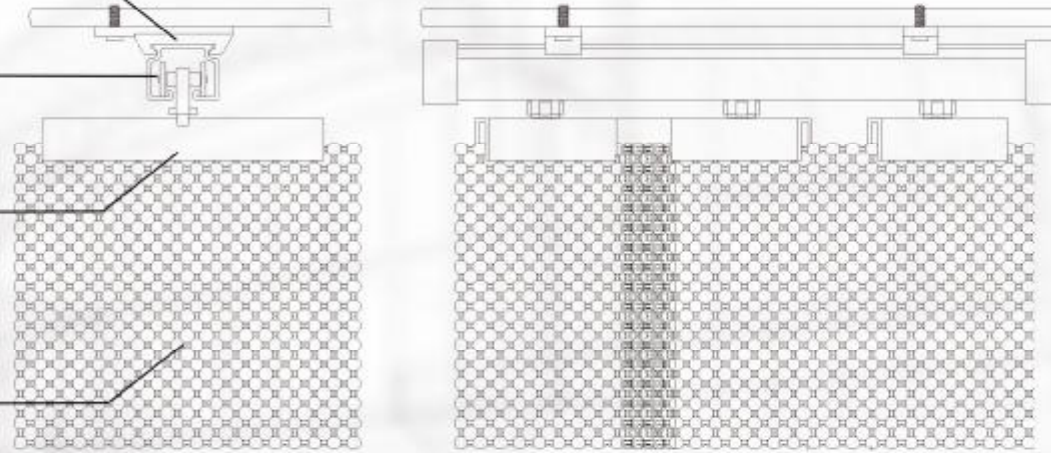

夹片
jaw

直轨
straight track



金属布直轨固定方式 Straight Track for Metal Drapery

轨道为合金材质，金属片夹住金属布并和滑轮连为一体，轨道任意弯曲平行弧度，可随意左右拉动。金属夹专为金属布设计制作并解决其收缩难题，满足高度在4米之内金属布帘褶皱垂直带至底部可满足顶装和侧装。

Material, aluminum, with wheel and clamps to hold drapery, to to be pulled on both directions, specially designed clamps can keep metal drapery from folding; to be installed under 4M clearance on wall or ceiling.

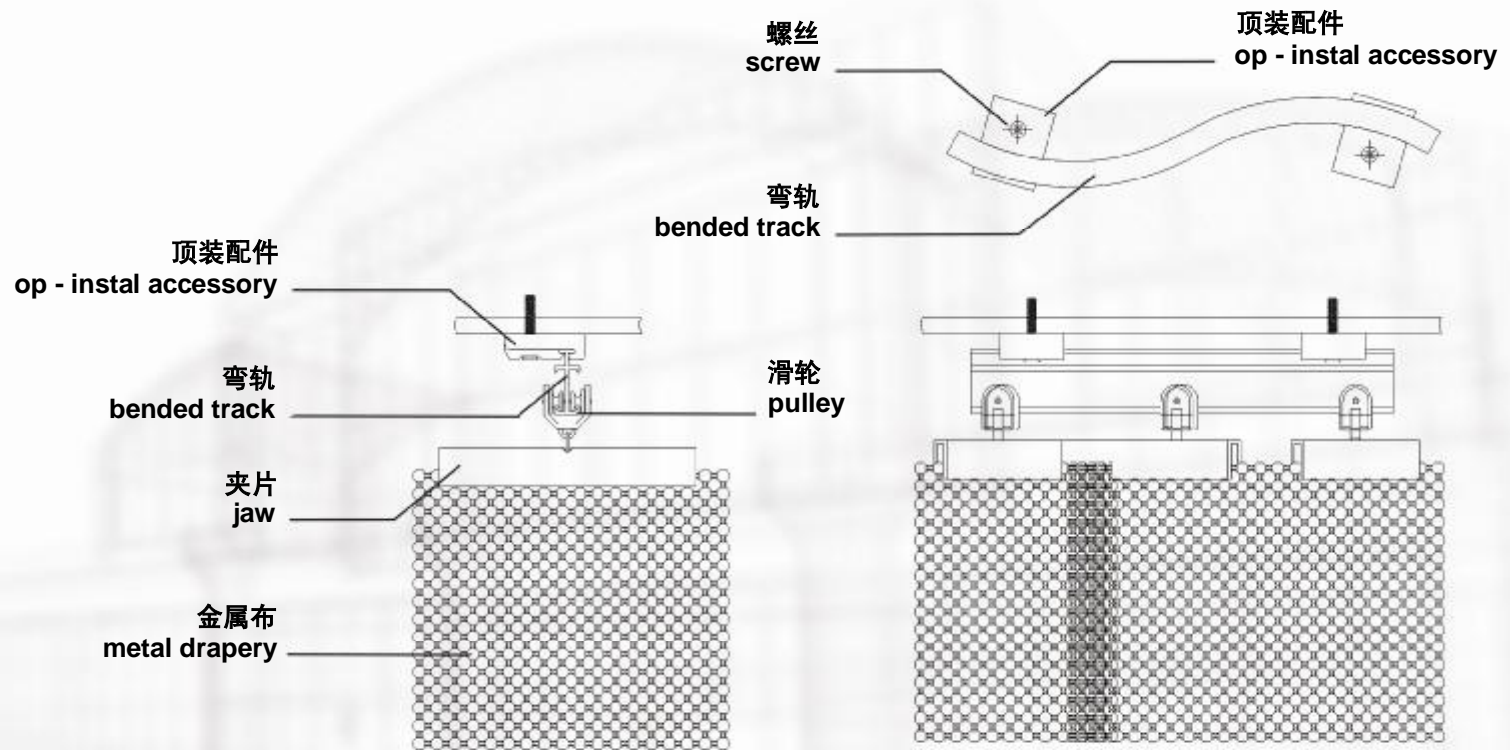

金属布弯轨固定方式 Bended Track for Metal Drapery

轨道为合金材质，金属片夹住金属布并和滑轮连为一体，轨道任意弯曲平行弧度，可随意左右拉动。金属夹专为金属布设计制作并解决其收缩难题，满足高度在4米之内金属布帘褶皱垂直带动至底部可满足顶装和侧装。

Material, aluminum, with wheel and clamps to hold drapery, to to be pulled on both directions, track can be bended on your angle. Specially designed clamps can keep metal drapery from folding; to be installed under 4M clearance on wall or ceiling.



JA-20-01

丝径: wire dia	2.0mm
孔径: dia	12.0mm
旋距: pitch of screw	12.0mm
厚度: thickness	13.0mm
重量: weight	3.0kg/m ²



JB-7-08

丝径: wire dia	1.0mm
孔径: dia	6.8mm
旋距: pitch of screw	7.2mm
厚度: thickness	6.8mm
重量: weight	2.0kg/m ²



JB-11-07

丝径: wire dia	1.1mm
孔径: dia	6.2mm
旋距: pitch of screw	6.7mm
厚度: thickness	6.2mm
重量: weight	1.7kg/m ²



JB-1-04

丝径: wire dia	1.2mm
孔径: dia	8.0mm
旋距: pitch of screw	9.5mm
厚度: thickness	8.0mm
重量: weight	2.0kg/m ²

金属网帘 Wire drapery

金属网帘由铝合金丝，铜丝，不锈钢丝等材料以螺旋方式编织而成，通过镀钛烤漆等方式给网帘表面处理成多种其他金属色。可用于大堂的屏风装饰，餐厅隔断等多类娱乐场所，在灯光的映照下呈现出如梦似幻的视觉效果。

Weaved with aluminum, copper or s.s.steel wire in way of screw forming, the wire drapery is to be painted after weaving into different colours upon clients requirement. It can be decorated in hotel, restaurant, entertainment as partition or any curtains you can imagine.



JB-11-31

丝径: wire dia	1.0mm
孔径: dia	6.2mm
旋距: pitch of screw	6.7mm
厚度: thickness	6.2mm
重量: weight	1.7kg/m ²



JB-1-18

丝径: wire dia	1.2mm
孔径: dia	8.0mm
旋距: pitch of screw	9.3mm
厚度: thickness	8.0mm
重量: weight	2.0kg/m ²



JB-1-19

丝径: wire dia	1.0mm
孔径: dia	6.8mm
旋距: pitch of screw	8.2mm
厚度: thickness	7.2mm
重量: weight	1.7kg/m ²



JB-1-05

丝径: wire dia	1.2mm
孔径: dia	6.9mm
旋距: pitch of screw	7.0mm
厚度: thickness	6.9mm
重量: weight	2.0kg/m ²

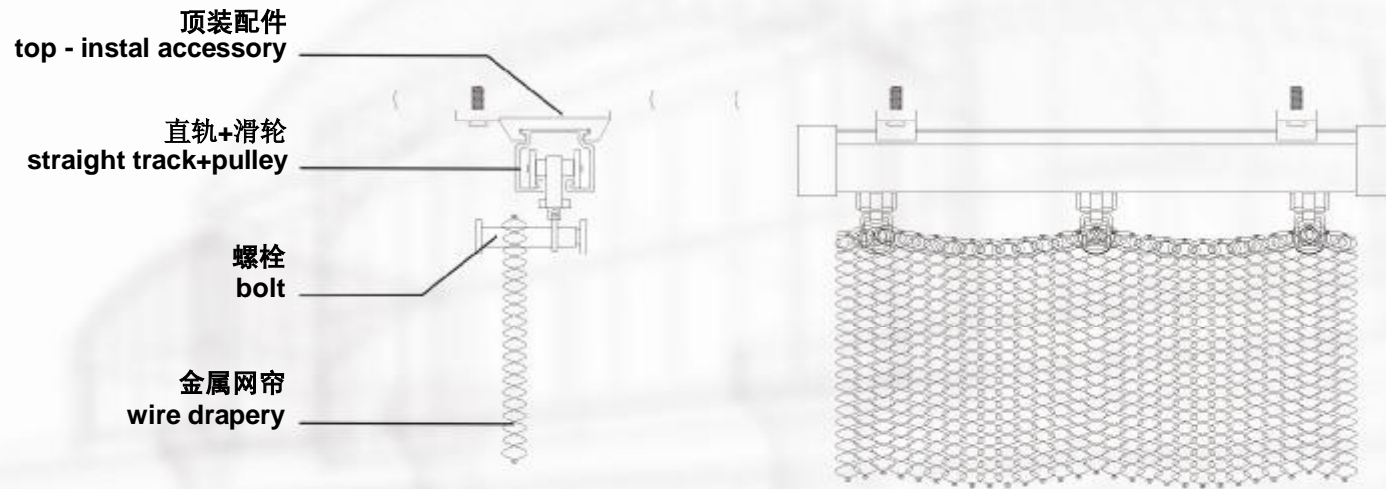

金属网帘直轨固定方式 Straight Track for Wire Drapery

轨道为合金材质，网帘连接滑轮配以控制间距的链条为一体，网帘可以随意左右拉动，整体美观安装方便。可满足顶装和侧装

Material, aluminum, with wheel link and chains to be pulled on both directions, the drapery can be pulled on both directions, easily to be installed on wall or ceiling.

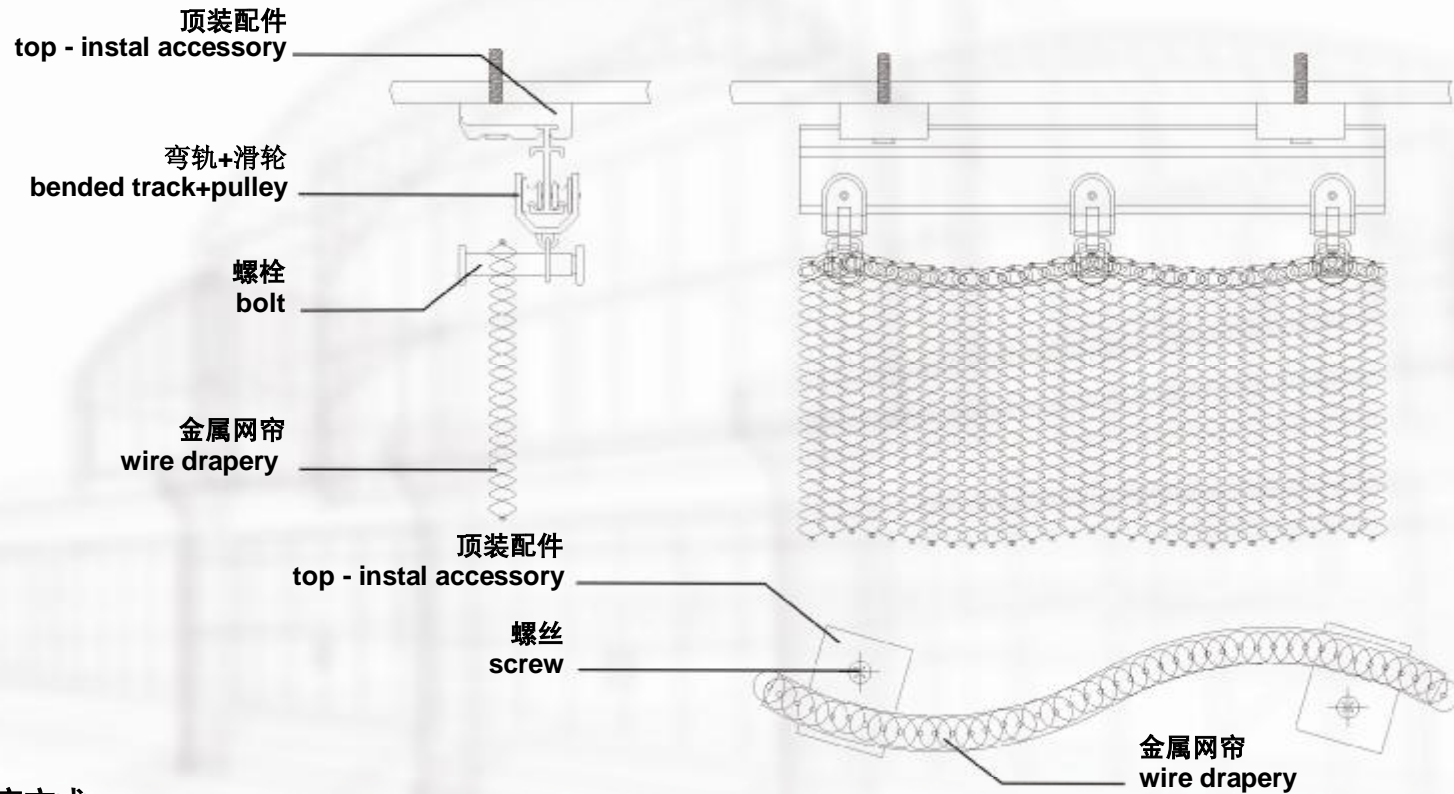

金属网帘弯轨固定方式 Bended Track for Wire Drapery

轨道为合金材质，网帘连接滑轮配以控制间距的链条为一体，网帘可以随意左右拉动，轨道任意弯曲平行弧度，也可作为直轨使用，可满足顶装。

Material, aluminum, with wheel link and chains to be pulled on both directions, track to be bended on your angle and can be used as straight track as well can be installed on ceiling.



YB-30

材质: material	AL
圈外径: outside ring dia	30.0mm
圈内径: inside ring dia	20.0mm
圈厚: thickness	1.0mm
重量: weight	3.16kg/m ²

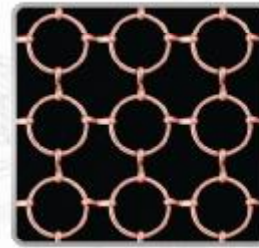

YB-20-38

材质: material	AL
丝径: wire dia	2.0mm
圈直径: ring dia	22.0mm
重量: weight	2.82kg/m ²

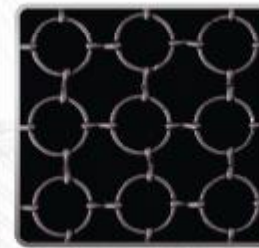

YB-20

材质: material	AL
丝径: wire dia	2.0mm
圈直径: ring dia	20.0mm
重量: weight	2.82kg/m ²

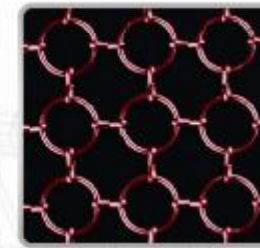

YB-20-08

材质: material	AL
丝径: wire dia	2.0mm
圈直径: ring dia	20.0mm
重量: weight	2.82kg/m ²

金属环网 Metal ring mesh

金属环网由铝合金，铜，碳钢等材料制作而成，再以金属扣或环环相扣的方式链接成片，结构紧密，颜色各异，多以垂直悬挂的方式作为隔断使用，如同一枚枚金钱般闪耀，诱人眼球。

Made of wires of aluminum, copper or steel, the ring mesh can be formed in any size or shape upon client need. The formed mesh is often hang as partitions in different colors which shines in unique metal light.



YB-12

材质: material	AL
丝径: wire dia	0.8mm
圈直径: ring dia	12.0mm
重量: weight	3.52kg/m ²



YB-25-71

材质: material	AL
丝径: wire dia	2.0mm
圈直径: ring dia	22.0mm
重量: weight	2.39kg/m ²

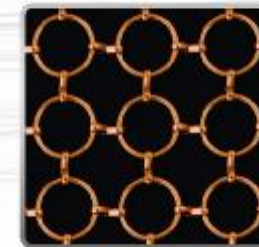

YB-25-18

材质: material	AL
丝径: wire dia	2.0mm
圈直径: ring dia	22.0mm
重量: weight	2.39kg/m ²



YB-25-17

材质: material	AL
丝径: wire dia	2.0mm
圈直径: ring dia	22.0mm
重量: weight	2.39kg/m ²



金属珠帘 Metal Bead Curtain

金属珠帘多由铜，碳钢，不锈钢等材料制成，内部中空，垂感绝佳，钢珠直径尺寸和颜色多样，可根据客户的不同需求定制，广泛用于商场门店，咖啡厅，酒店大堂等，可配合环境选择疏密程度，以达到最佳效果。

Made of hollow metal balls of copper, steel or s.s. steel, the bead is excellent in draping. Varieties of size and colours are available upon your requirement. The bead curtain is widely used in cafes, hotel lobbies and so on. Density between lines can be adjusted accordingly to reach a satisfactory result.



南瓜形	南瓜形	南瓜形	南瓜形	南瓜形	南瓜形	南瓜形	南瓜形	南瓜榄形	圆形	圆形
直径: 3.2mm diameter	4.0mm	4.5mm	5.0mm	6.0mm	8.0mm	10.0mm	5.0mm	2.4mm	3.5mm	
重量: 15g/m weight	30g/m	35g/m	40g/m	50g/m	90g/m	120g/m	40g/m	12g/m	23g/m	



圆形	圆形	圆形	圆形	圆形	圆形	圆形	榄形	榄形长短珠	长短珠
直径: 4.0mm diameter	4.5mm	5.0mm	6.0mm	8.0mm	10.0mm	12.0mm	3.2mm	3.2mm	4.0mm
重量: 32g/m weight	34g/m	37g/m	44g/m	90g/m	132g/m	168g/m	20g/m	20g/m	30g/m

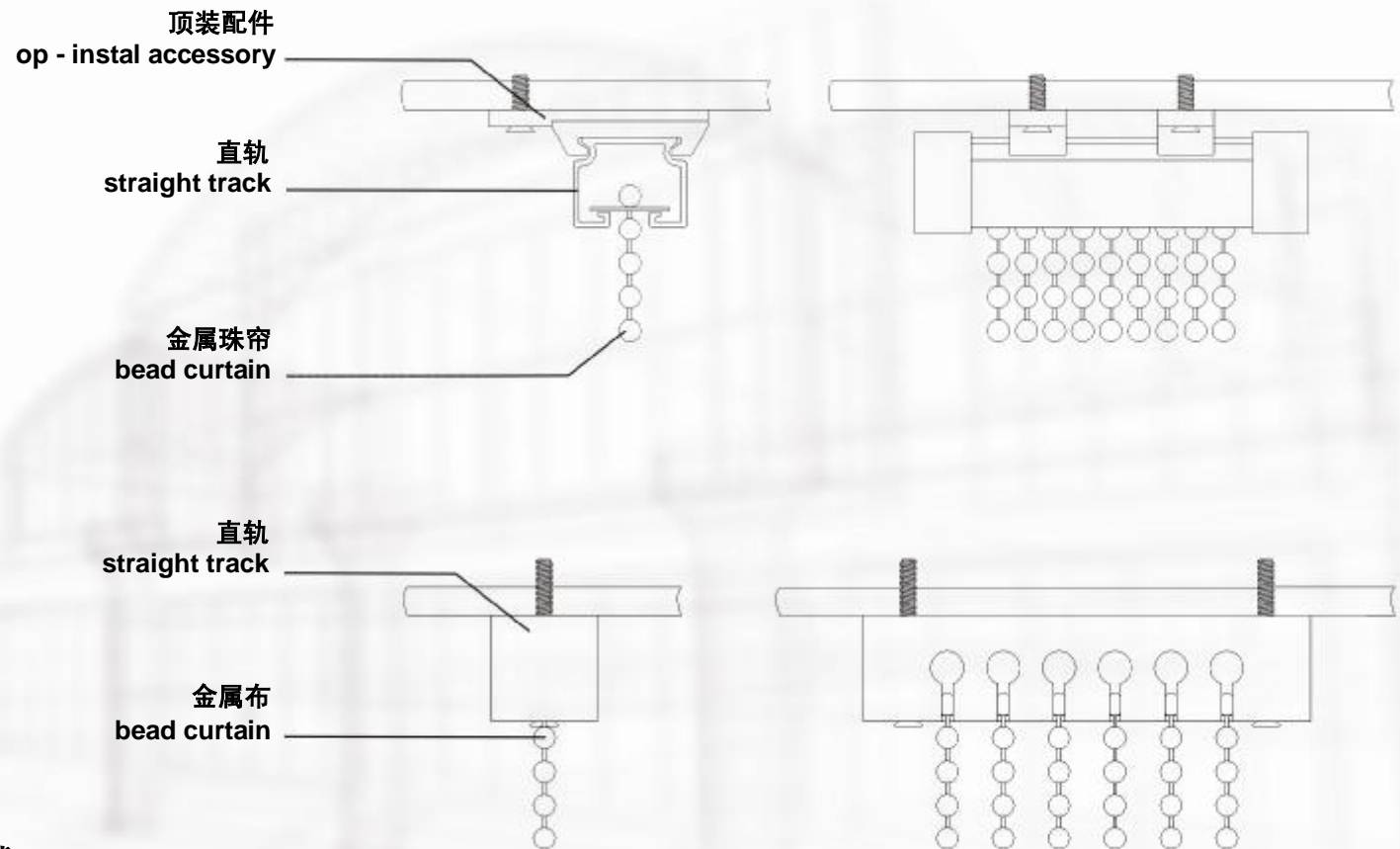

金属珠帘直轨固定方式 Straight Track for Bead Curtain

轨道为不锈钢材质，侧面一边有孔以便以珠帘进入悬挂，可控珠帘间距精度 $\geq 3\text{mm}$ ，安装便捷。可满足顶装。

Material, s.s.steel, with holes on one side to hold bead line, pitch accuracy $\geq 3\text{mm}$, simple installation on wall or ceiling.

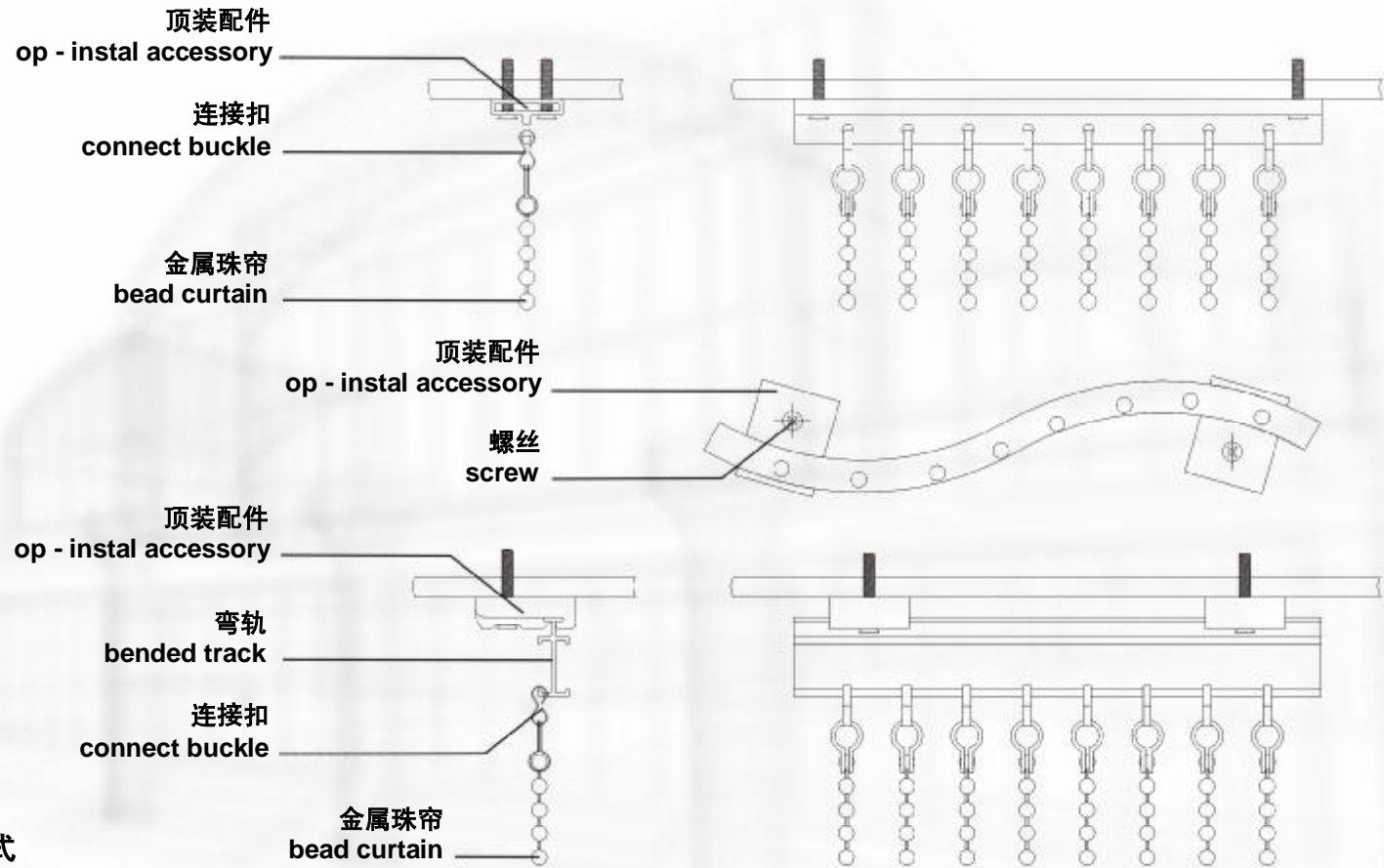

金属珠帘弯轨固定方式
Bended Track for Bead Curtain

轨道为不锈钢材质，侧面一边有孔便以珠帘进入悬挂，可控珠帘间距精度 $\geq 3\text{mm}$ ，安装便捷。可满足顶装。

Material, aluminum, with hooks & linkings, can be bended into your angle, pitch accuracy $\geq 5\text{mm}$, can be used as straight track as well.



上海市徐汇区滨江规划展示中心 Shanghai Xuhui Binjiang Planing & Exhibition Center

上海市徐汇区滨江规划展示中心位于卢浦大桥南侧的浦江西岸，与2010年上海世博会园区隔江相望，传承龙华千年文化，保留工业遗产印记，融合浦江景观，林荫大道，生态绿化，休闲设施为一体，是中心城区罕见的高品质公共开放空间，以不锈钢钢丝绳网承托下，体现出更强的现代感。

Located in the west bank of Huangpu River and south of Lupu Bridge, Shanghai Xuhui Binjiang Planing & Exhibition Center faces the Shanghai World Expo 2010 across the River. The center is to inherit traditional culture and reserve the industrial heritage stamp, mix together with River landscape, boulevard, eco green and leisure. The metal wire mesh shows the modern feeling of quality life of town center.



上海金缕金属材料有限公司



GOLD SILK



智能燃气大厦
Intelligent Gas Building

比起大气恢弘的大会议室相比，监控中心更为现代化，体现了多样性的科技元素，而不锈钢钢丝绳网的运用使得原本以实用为主的监控室有了股艺术气息。

The monitoring center of the building is full of modern technique atmosphere for the decoration of wire mesh application.

上海金缕金属材料有限公司



GOLD SILK

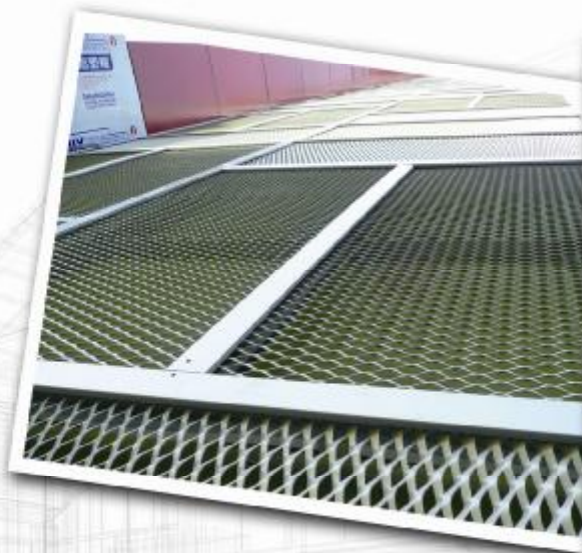

上海雅源阁酒店 Intelligent Gas Building

坐落于徐汇区田林路的雅缘阁酒店以本帮菜系为主，外墙装饰采用了多块扩张网板为幕墙，白天在阳光下整体性出色，而在夜晚观看外围又是另一番景象，网板内以金黄色灯光映射，熠熠生辉格外耀眼。

Situated in Tianlin St., Xuhui District, the Restaurant mainly serves Shanghai local food. The outside wall was covered with expanded mesh which shows an overall excellence under the sunshine and quite a different view with golden light inside during the night.

上海金缕金属材料有限公司



上海世博会瑞士馆 Switzerland Pavillion of Shangai Expo. 2010

瑞士馆外围的巨大的帷幕采用的是金属绳网，帷幕上悬挂着无数的红色能量“小太阳”，它能从太阳能或者照相机闪光灯产生的光能发生反应，从而发出发光。这种新颖独特的构思，意在表现瑞士馆内外的“环境影响”，整个建筑充分体现了城市和乡村相互依存、互惠共生的关系，强调人类、自然与科技的完美平衡。

The interactive, intelligent facade enveloping the pavilion is a curtain of woven aluminium elements under which visitors pass to access the urban area on the ground floor of the building. LED lights comprised of an energy source, a storage unit and a consuming unit are incorporated into the facade. The energy produced is made visible in the form of flashes that are triggered by the pavilion surroundings, such as the sun or flashes made by visitor cameras. Thanks to the storage of energy in each individual cell, the facade is also active at night, when the cells will trigger each other



上海金缕金属材料有限公司



GOLD SILK



上海苏浙汇酒店(外高桥店)
Jade Garden (Waigaoqiao)

外高桥店沿袭苏浙汇“体验式用餐”的经营特色，在店面装潢上使用了多幅金属布，既融合中国古典元素的传统韵味，又汇聚了现代西方的时尚气息，充分地将中国古风与现代设计完美融合。

Jade Garden (Waigaoqiao) has adopted “experiencing dining” management style by decorating windows with metal drapery which has exhibited modern western fashion together with traditional Chinese style.

上海金缕金属材料有限公司



香港DFS Hong Kong DFS

进入任何一家DFS店, 你会即时陷入名牌的海洋。Burberry、Cartier、Celine、Chanel、Dior、Fendi、Gucci、Hermès (爱马仕)、Loewe 等品牌奢侈品让人眼花缭乱, 外部展示橱窗和门厅Loewe展示柜内皆使用了深金的金属布, 将众多名牌产品的奢华衬托的淋漓尽致。

The luxury and dazzling fashion can easily be seen in any of the DFS center, Louis Vuitton, Burberry, Bvlgari, Cartier, Celine, Chanel, Dior, Fendi, Gucci, Hermès, loewe which are exhibited more elegantly by the modern golden metal drapery decorated in window shows and cabinets.



上海金缕金属材料有限公司



GOLD SILK

浦江二号 Pujiang No.2 Hotel

坐落于陆家嘴的浦江二号酒店，临靠于黄浦江畔，紧靠东方明珠对望着浦西新外滩，以绒稠窗帘，水晶吊灯和金属布为三大装饰特点，以突显典雅高贵的用餐环境。

Located in Lujiazu, along the Yangtze River and facing Shanghai Bund, Pujiang No.2 Hotel was newly decorated with silky wire drapery, crystal beads, chandelier and metal drapery showing elegant and luxury dinning hall.



上海金缕金属材料有限公司



长春(自然美)医美美容医院
**Changchun (Natural Beauty)
Health Beauty Hospital**

医美美容医院以奢华、时尚、高贵、典雅的装修风格，诠释了春城全新概念的造美空间，让医学与美学在无影灯下实现完美融合。洁白的楼体悄然立于闹市，少了几许喧哗却多了几分傲然。漫步典雅的空间采用了轻薄的金属网帘，如同轻纱幔帐般，又有淡淡的竹香缭绕，体现了崇尚自然的装修风格，让踏入医美的人身心得得到完全的放松。

Our hospital represents the newest beauty space in Changchun with its luxury, fashion and elegant decoration. The white building stand quietly in the noisy street adding some extra proud. The style decoration of metal mesh in our lounge welcomes our beloved guests where you will have a feeling of a great relax.



GOLD SILK

常熟金海华丽嘉酒店 Kingrace Hotel Changshu

常熟金海华丽嘉酒店坐落在江南名城常熟中心地段，远眺虞山，穿梭与绝妙山景与奢华情怀之间。橘红色的网帘配合着暖色调的装修风格，使每位入住的嘉宾都能享受总统套房般的豪华享受和如同回家的温馨体验。

Located in the downtown of famous city Changshu in Jiangnan, the hotel overlooks Yushan Hill. The orange wire drapery shows a warm colour and makes you feel at home and luxury.



上海金缕金属材料有限公司



香港车展(奥迪一汽展厅)
**Audi Show Room of FAW
in Hong Kong Auto Fair**

奥迪是整个汽车历史中最具神话而多彩的传奇之一，其历史可以追溯到一百多年以前，“创新科技，启迪未来”是奥迪的科技口号，以超高幅网帘作为背景幕，体现了奥迪磅礴的气魄，也标志着金缕技术的成熟。

Audi is the most legendary and colorful auto in car history which can be traced back hundred years ago. "Innovation and technology, enlighteningFuture "is the slogan of Audi's technology. The supper high drapery backdrop reflects majestic spirit and the mature technology of Jinlv.





GOLD SILK

上海南京路伊势丹商场 Shanghai Westgate Mall in Nanjing Rd

在市中心热门地段梅陇镇的著名商场, 3-5层扶梯与商铺的连接处皆使用了金属环网作为隔断装饰材料, 淡黄色的灯光与环网的阴影的结合让原本平凡无奇的白色墙面平添了一份生机。

Situated at the Shanghai commercial center, Westgate Mall was decorated with metal ring mesh as partition between escalators and shops. The yellow light mixed with shadow of metal ring mesh exhibit a lively picture from the white wall.



上海金缕金属材料有限公司



GOLD SILK

无锡渝派富豪酒店 Wuxi Chongqing Fuhao Restaurant

无锡市渝派富豪餐饮有限公司是一家经营“特色川菜”的川菜主题连锁企业，凭借准确的定位赢得了无数食客的青睐，多幅方形金属环网通过“天圆地方”的意境，将渝派富豪的内涵魅力体现无疑。

Wuxi Chongqing Fuhao Dinning Co., Ltd is a chain restaurant serving typical Sichuan food. Based on the theory of "hemispherical dome" metal ring mesh was designed in several square shape for decoration to exhibit clearly the Chongqing food.

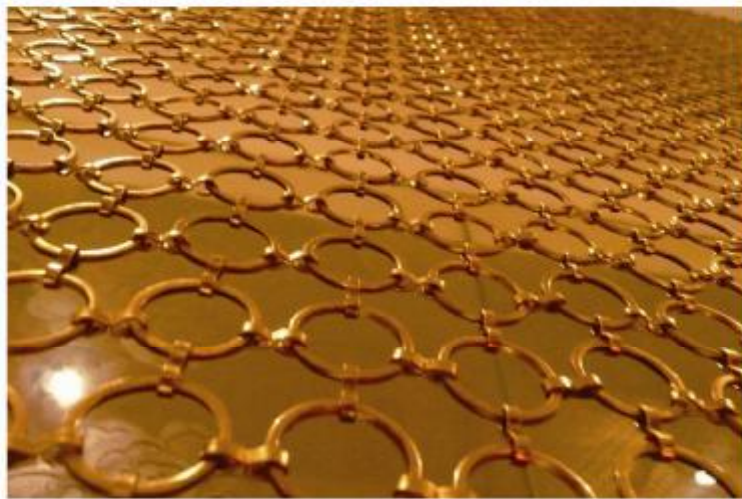

上海金缕金属材料有限公司



GOLD SILK

浦江二号

Wuxi Chongqing Fuhao Restaurant

坐落于陆家嘴的浦江二号酒店，临靠于黄浦江畔，紧靠东方明珠对望着浦西新外滩，除去已使用的金属布，金属珠帘则是另一大亮点，银色的垂直线条如雨丝般细密，并以多种形式表现，廊道帘状的，楼梯中幕墙般的，还有接待台顶部弧形多层次的，不得不佩服设计者奇思妙想的设计理念。

Located in Lujiazui, along the Huangpu River, facing Shanghai Bund and close to the Pearl of Orient, Pujiang No.2 Hotel was also decorated with our metal bead curtains which is draping silkily like rains, claddings in ladder area, arc shaped in reception to satisfy designers wonderful ideas.

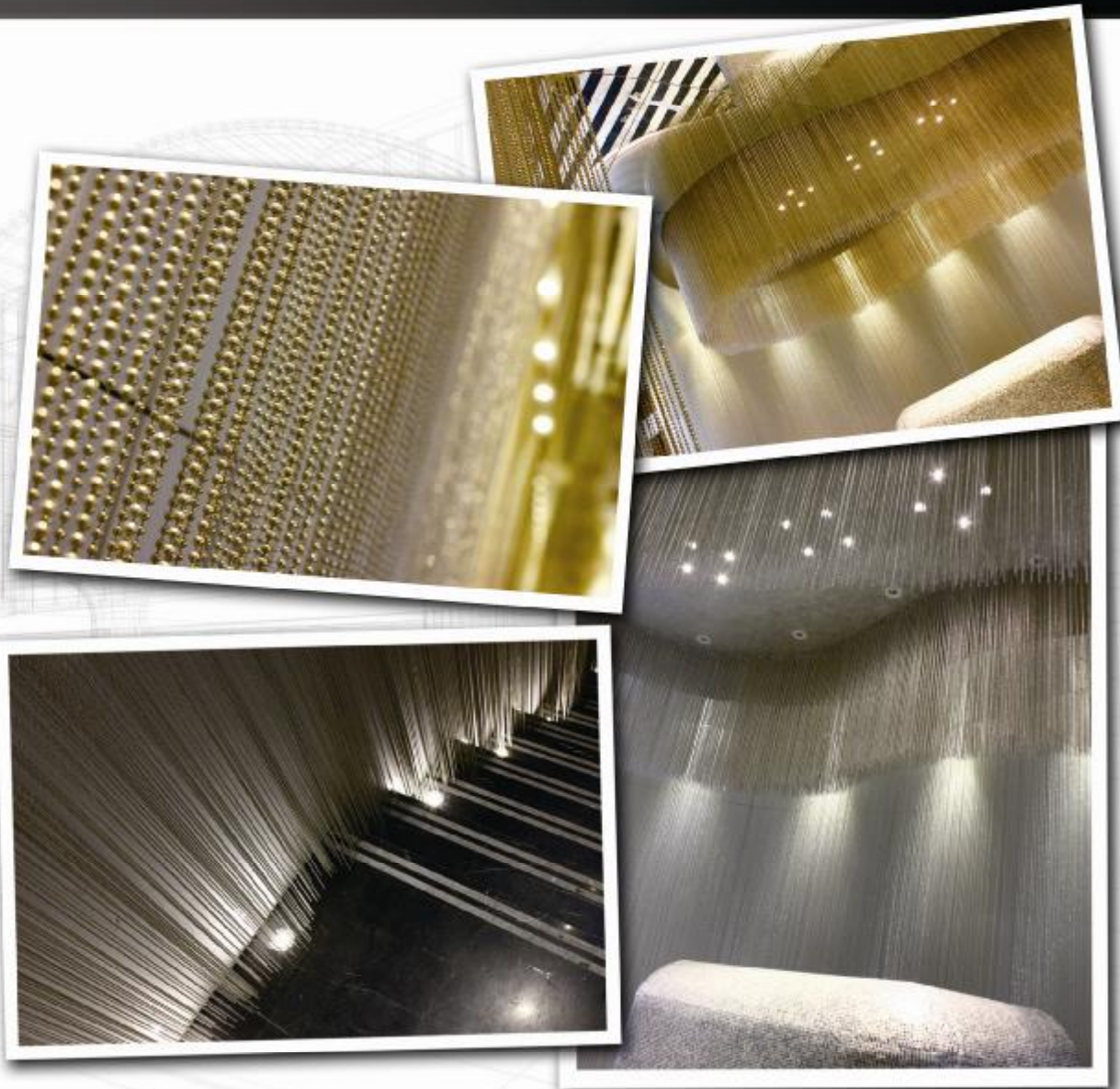

上海金缕金属材料有限公司



GOLD SILK



上海南京路伊势丹商场
Shanghai Westgate Mall in Nanjing Rd

如果说之前在扶梯处所用的金属环网是种点缀，那在女性用品商铺的金属珠帘则是装饰风格中的主基调，柔性的珠帘和半弧多弧的固定手法，隐喻着女性的阴柔之美。

The semi or multi arc shaped metal bead curtain is designed here for women products and presents a typical beauty of women.

上海金缕金属材料有限公司



GOLD SILK

张家港国际酒店 Zhangjiagang International Hotel

为您和您的家人营造轻松而惬意的假期体验，在简约而不失典雅的整体布局内选择金色珠帘作为隔断材料，恰到好处，使区域分割鲜明，充满生机与活力，充分地展示出了张家港国际酒店创新的装饰格调和设计品位。

To create a relaxed and pleasant holiday experience for you and your family, the Hotel was decorated with our elegant wire drapery for partition separating different functions and creating a fresh style and design.



上海金缕金属材料有限公司

案例合作单位
comapny

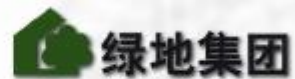
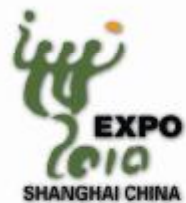

上海金缕金属材料有限公司



GOLD SILK

上海金缕金属材料有限公司

Gold Silk (Shanghai) Metal Incorporation

Tel: +86-021-64827090

Address: 上海市徐汇区漕东支路1-5号凯翔商
务中心303室

Fax: +86-021-6483-5015

E-mail: info@jinlv.cn

Http: www.jinlv.cn

上海金缕金属材料有限公司